

# RollerMouse Pro

*Wireless*

Product  
Manual



Contour



## What's in the Box?

1. RollerMouse Pro
2. Wrist rest
3. Keyboard Risers
4. Dongle
5. USB extender
6. USB charging cable



## User guide

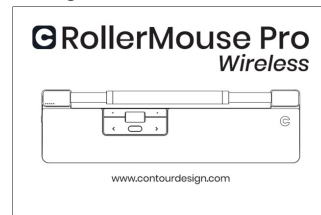



## Functions

- A. Cursor speed
- B. Power switch
- C. Rollerbar
- D. Copy
- E. Paste
- F. Left-click
- G. Right-click
- H. Scroll wheel
- I. Double-click

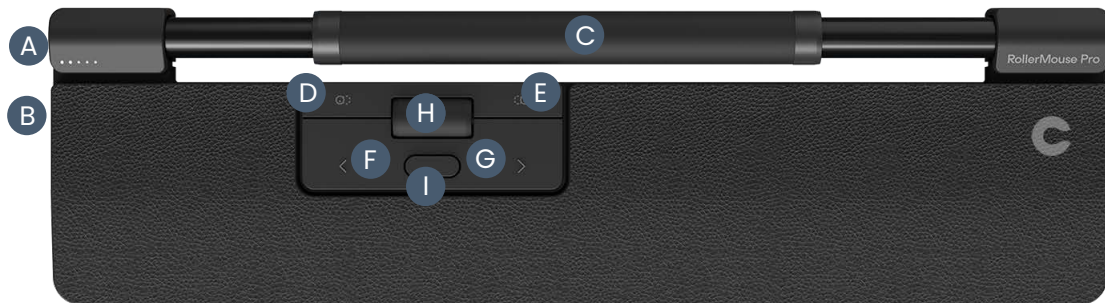



## Quick Start

### 1. Connect via Bluetooth

Power on RollerMouse Pro (button **B**). On your computer, navigate to the area of settings regarding Bluetooth connections. Select the option to add or discover a Bluetooth device. Your RollerMouse Pro will automatically be recognized, select it for the computer to start Bluetooth connection.

### 2. Connect via USB dongle

Insert USB dongle into available USB port and power on your RollerMouse Pro. Your computer will recognize your new device and connect automatically.

### 3. Connect via a wired USB connection

Connect the USB cable to your RollerMouse and into an available USB port on your computer. Your computer will recognize your new device and connect automatically.

## Cursor Speed (DPI)

Press the Cursor speed (button **A**) to cycle through cursor speeds. There are speed selections which range from slow (600 DPI) to fast (2800 DPI). Speed can be identified by the LED lights as shown. Hold Cursor speed (button **A**) for 8 seconds to default settings.

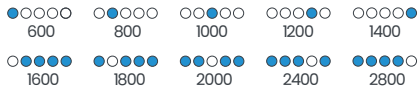

## Battery level

Battery level is shown when the RollerMouse Pro is powered on or plugged in.

If battery level is below 20%, a single light will flash to indicate the need to charge the device.



## Rollerbar click force adjustment

Click force refers to the level of resistance when clicking the Rollerbar. To adjust click force, press and hold button **A** (Cursor speed) then press and release button **C** (Rollerbar). Move button **H** (Scroll wheel) up and down to adjust the click force settings.

To disable the Rollerbar click function, adjust the click tension until all LEDs are illuminated.

## Rollerbar click volume adjustment

The Rollerbar has 6 different click volume settings. To change the click volume, press and hold button **A** (Cursor speed), while continuing to hold **A** (Cursor speed), press and release button **H** (Scroll wheel), the LED light will show current click volume setting. Move button **H** (Scroll wheel) up/down to adjust volume setting. Release button **A** to confirm adjusted click volume.

To disable the Rollerbar click volume, adjust the click volume until all LEDs are illuminated.

## Charging

To charge your RollerMouse remove the USB extender and dongle from the charging cable. Plug the USB-C end into the RollerMouse and connect to a USB-A at your computer.

Your RollerMouse will be fully charged in approx. 5 hours.  
You may continue to use the RollerMouse as it charges.



## Wireless connection

Once powered on, the device is in automatic mode which will pair to the first available connection. The device will attempt to connect to the dongle first. If no connection is made, the device will attempt to connect via Bluetooth using the pairing information that is already in the unit. If no pairing information is available, it will start Bluetooth pairing mode and remain in that pairing mode for about two minutes.

If the device is left in automatic pairing mode, the RollerMouse will cycle through the above steps each time it's powered off and then powered back on again.

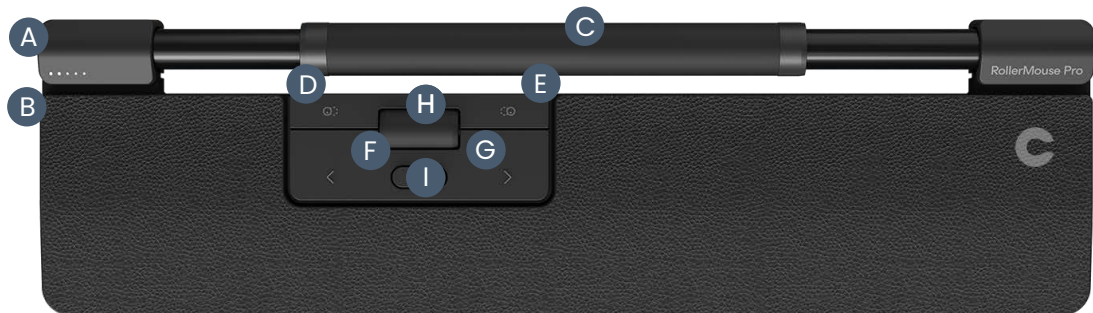

## Pairing and secondary options

1. Restart Bluetooth pairing:  
Press button **A**. While continuing to hold **A**, press and release button **F** two times, then release button **A**.
2. Select Bluetooth-only connectivity:  
Press button **A**. While continuing to hold **A**, press and release button **F** three times, then release button **A**.
3. Select dongle-only connectivity:  
Press button **A**, while continuing to hold **A**, press and release button **G** three times, then release button **A**.
4. Restore pairing with dongle:  
Unplug then re-plug the dongle to the unit to enable pairing. Hold the device close to dongle and press button **A**. While continuing to hold **A**, press and release button **G** two times, then release button **A**.
5. Reset wireless function to automatic pairing mode:  
Press button **A**. While continuing to hold **A**, press and release button **F**, then release button **A**.

When the device is plugged with the USB cable, this connection overrides wireless connectivity.

Please visit [contourdesign.com/BT](http://contourdesign.com/BT) for further information about Bluetooth.



## Keyboard risers

Before using your RollerMouse Pro, please take a moment to adjust your keyboard.

If you are using other keyboards than Contour's Balance Keyboard, you can use the Keyboard risers to achieve the desired keyboard height and angle. Simply place the Keyboard risers under your keyboards feet - as the keyboard was lying on the table.

For a proper ergonomic position the front edge of the the keyboard should be as close to the Rollerbar as possible. We recommend to use negative tilt helping you to hold a neutral wrist position and decreasing the extension of your fingers.



Negative tilt



Neutral flat



Neutral elevated



Postive tilt



## Software driver

All Contour's ergonomic products are plug-and-play. If you want to customize your RollerMouse Pro, we recommend to download the free driver available at:

[contourdesign.com/drivers](https://contourdesign.com/drivers)

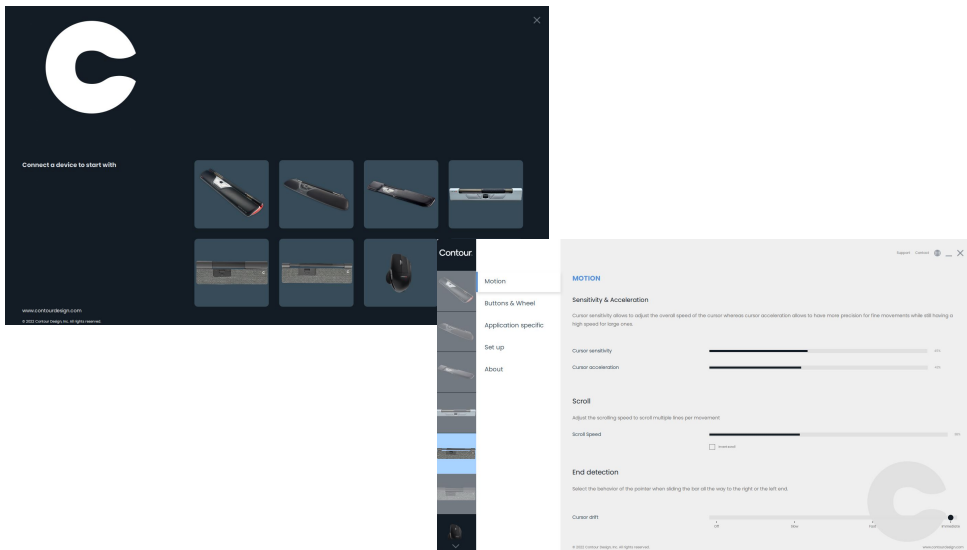

## Battery disposal

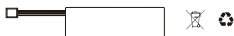
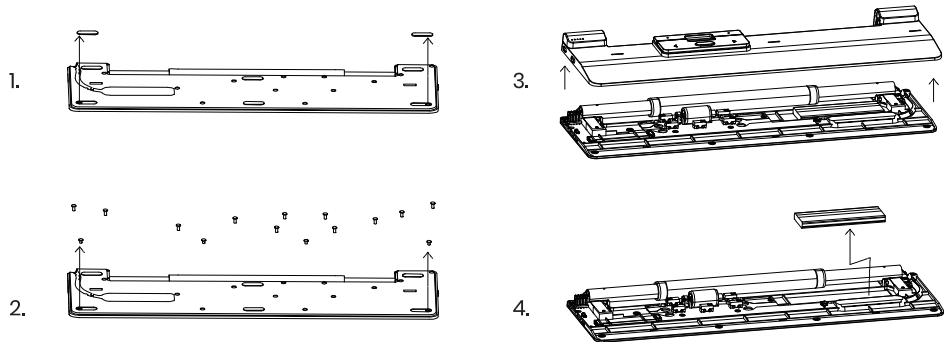

# Contour

## Contour Design Nordic A/S

Nyropsgade 41-43, 1. floor  
DK-1602 Copenhagen V, Denmark  
Phone: +45 70 27 02 27  
Email: info@contourdesign.com

## Contour Design, Inc.

10 Industrial Drive  
Windham, New Hampshire 03087, USA  
Phone: (603) 893-4556  
Email: ergoinfo@contourdesign.com

For more information please visit:  
[www.contourdesign.com](http://www.contourdesign.com)

Tested to comply with FCC and  
IC standards.



### FCC Statement

Changes or modifications not expressly approved by the party responsible for compliance could void the user's authority to operate the equipment.

This equipment has been tested and found to comply with the limits for a Class B digital device, pursuant to Part 15 of the FCC Rules. These limits are designed to provide reasonable protection against harmful interference in a residential installation. This equipment generates uses and can radiate radio frequency energy and, if not installed and used in accordance with the instructions, may cause harmful interference to radio communications.

However, there is no guarantee that interference will not occur in a particular installation. If this equipment does cause harmful interference to radio or television reception, which can be determined by turning the equipment off and on, the user is encouraged to try to correct the interference by one or more of the following measures:

- Reorient or relocate the receiving antenna.
- Increase the separation between the equipment and receiver.
- Connect the equipment into an outlet on a circuit different from that to which the receiver is connected.
- Consult the dealer or an experienced radio/TV technician for help.

This device complies with part 15 of the FCC rules.

Operation is subject to the following two conditions  
(1) this device may not cause harmful interference, and  
(2) this device must accept any interference received, including interference that may cause undesired operation.

### IC Statement

This device complies with Industry Canada's licence-exempt RSSs. Operation is subject to the following two conditions:

1. This device may not cause interference; and
2. This device must accept any interference, including interference that may cause undesired operation of the device.

The term "IC:" before the certification/registration number only signifies that the Industry Canada technical specifications were met. This product meets the applicable Industry Canada technical specifications.

### Warranty

If there is a functional defect due to faulty manufacturing, we will replace the product. This warranty does not cover damage that results from misuse of the product.

### Attention!

If you attempt to dismantle your "RollerMouse Pro" you will invalidate your warranty.